

# SOUNDWARRIOR

Shiroshita Industrial Co., Ltd.

城下工業株式会社

1-1-58 Tokiiri, Ueda, Nagano, 386-0015 JAPAN

Email: [userinfo@shiroshita.com](mailto:userinfo@shiroshita.com)

<http://www.shiroshita.com>



Facebook

<https://www.facebook.com/SoundWarrior.jp>



Twitter

[https://twitter.com/SoundWarrior\\_jp](https://twitter.com/SoundWarrior_jp)

Printed in Japan  
18QA0337A5

# SOUNDWARRIOR

Headphone Amplifier with Tube Buffer

## SWD-HA10

## User Guide

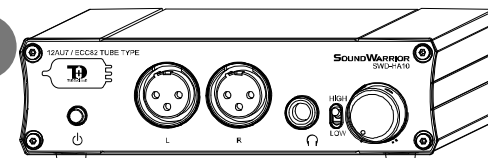

Sound Warrior's Class D headphone amplifier with 12AU7 tube buffer

### Table of Contents

1	IMPORTANT SAFEGUARDS.....	2
1-1	Safety Graphic Symbols .....	2
1-2	Warning .....	2
1-3	Caution .....	3
1-4	Accessories.....	3
2	PART NAMES AND FUNCTIONS .....	4
2-1	Front View.....	5
2-2	Back View .....	5
2-3	Side View .....	5
3	SETTING POWER MODE .....	5
4	SETUP .....	6
4-1	Attaching the Protective Cushions.....	6
4-2	Changing Design of the Front Panel .....	6
5	CONNECTIONS.....	7
5-1	ANALOG IN Connecting LINE Input .....	7
5-2	ANALOG OUT Connecting Parallel Output ..	7
5-3	Connecting Balanced Headphones .....	7
5-4	Connecting Un-balanced Headphones .....	7
5-5	DC IN Connecting Power Input .....	7
6	HOW TO USE.....	8
6-1	Turn on Main Unit .....	8
6-2	Set up Output Gain .....	8
6-3	Listen Through Balanced Headphones.....	8
6-4	Listen Through Un-balanced Headphones...	8
6-5	Turn off the Main Unit.....	8
7	FAQS.....	9
7-1	Does not Turn on. ....	9
7-2	No Sound or Intermittent Sound .....	9
7-3	No Sound and the Power is off.....	9
8	TECHNICAL SPECIFICATIONS .....	10



Thank you for purchasing SWD-HA10, "Headphone Amplifier with Tube Buffer".

**READ AND FOLLOW ALL SAFETY INSTRUCTIONS BEFORE USING THE PRODUCT.  
KEEP THE USER GUIDE WITH A WARRANTY CARD FOR FUTURE REFERENCE.**



## 1 IMPORTANT SAFEGUARDS

### 1-1 Safety Graphic Symbols







The following symbols are used to define the degree of danger when abused and misused the product.

 <b>WARNING</b>	.....	Negligence of the instructions may lead to mishandling that may cause death or serious injury.
 <b>CAUTION</b>	.....	Negligence of the instructions may lead to mishandling that may cause a minor injury, property or financial damage.

The following symbols are used to indicate the actions that should be followed.

	.....	This symbol indicates actions that call users' attention.
	.....	This symbol indicates prohibited actions that must not be performed.
	.....	This symbol indicates compulsory actions that must be performed.

### 1-2 WARNING

1-2-1		In the following cases, immediately turn off the power switch and disconnect the AC adapter from power outlet. Then contact us for repair. <ul style="list-style-type: none"> <li>• Smoke, strange odor or strange sound.</li> <li>• Damaged elements or cables.</li> <li>• Penetration of liquids or foreign objects, or the like.</li> </ul>
1-2-2		Do not prevent the product from releasing heat by covering with a cloth, etc. Do not place the product in a stuffy room, narrow room or the like. This could result in fire.
1-2-3		Do not use the product outdoors, in a bathroom or the like. Penetration of liquids or foreign objects could result in fire or electrical shock. If liquids or foreign objects should enter the product, immediately disconnect the AC adapter from the power outlet and contact us for repair.
1-2-4		Never disassemble and modify. Modification and/or disassembly of the product or accessories could result in fire or electrical shock. Contact us for repair.
1-2-5		Do not use except the supplied AC adapter. Do not use over the rated voltage.
1-2-6		Do not place anything on the product or cover it with a cloth, etc. Do not place anything on the cords or damage it. This could result in fire or electrical shock.

## 8 TECHNICAL SPECIFICATIONS

### General

Type of Tube	12AU7
Power Supply	AC100V 50/60Hz (AC adaptor), DC15V (Main Unit)
Power Consumption	Max 18W
Operating Temperature	0 - 40°C
External Dimensions	W145.4mm × H40mm × D165mm (Protruding part not included)
Weight	Approx. 0.85kg

### Analog Input

Connector	RCA pin jack
Rated Input Power	+4dBm
PARA Output	Parallel Output (Skip LINE input signal)

### Headphone Output

Balanced Output	XLR 3pins, female, L/R (1:GND 2:HOT 3:COLD)
Unbalanced Output	φ6.3mm stereo jack
Output Switch	LOW/HIGH
Max Output	100mW x 2 at 40Ω 40mW x 2 at 300Ω
Frequency Response	10Hz - 50kHz
Recommended Headphones	Impedance 30Ω - 300Ω

### Accessories

AC adaptor & cord ×1, Vertical sheet ×1, Hex wrench ×1,  
Protective Cushion ×4, User guide ×1, Warranty Card ×1

※Design and specifications are subject to change without notice.

**1-2-7**  Clean the power plug periodically with a soft and dry cloth. Accumulated dust could result in fire.

**1-2-8**  Do not touch the product, the connected devices, the connecting cords, the AC adaptor, etc. during a lightning storm. This could result in electrical shock.



### 1-3 CAUTION

**1-3-1**  Do not place the product on an unstable surface. This could result in falling and cause an injury. Place the product away from walls and other devices to release heat sufficiently.

**1-3-2**  Do not place the product in the following places. This could result in fire or electrical shock.

- Highly humid or dusty places.
- Places with smoke or oily smoke. (A kitchen, a humidifier or the like)

**1-3-3**  Place the product vertically or horizontally on a stable surface.

**1-3-4**   Do not touch the AC adapter with a wet hand. This could result in electrical shock. Do not pull the cord when disconnected. Hold the plug and disconnect. Disconnect the AC adapter from the power outlet when not used for a long time.

**1-3-5**  Disconnect the AC adapter from the power outlet when cleaning. Use a dry cloth to clean the product. Do not use thinner, alcohol or the like.

**1-3-6**  Turn the volume down before turning on the product. The loud sound could result in hearing impairment or failure of the product.

### 1-4 Accessories

- |                                 |    |                      |    |
|---------------------------------|----|----------------------|----|
| ● AC adapter & cord             | ×1 | ● Protective cushion | ×4 |
| ● Text sheet for vertical setup | ×1 | ● User Guide         | ×1 |
| ● Hex key                       | ×1 | ● Warranty Card      | ×1 |

## 2 PART NAMES AND FUNCTIONS

Front View

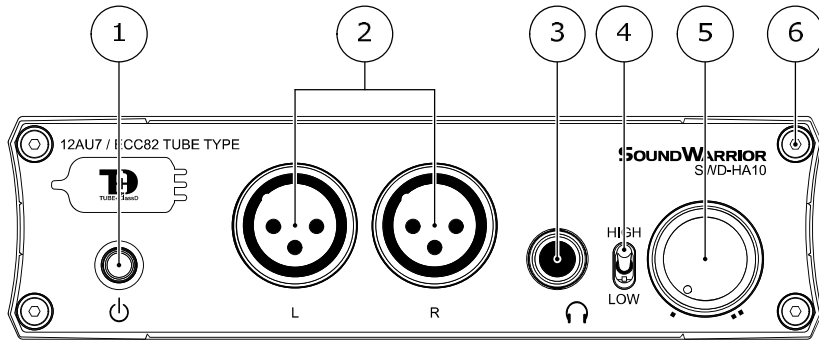

Back View

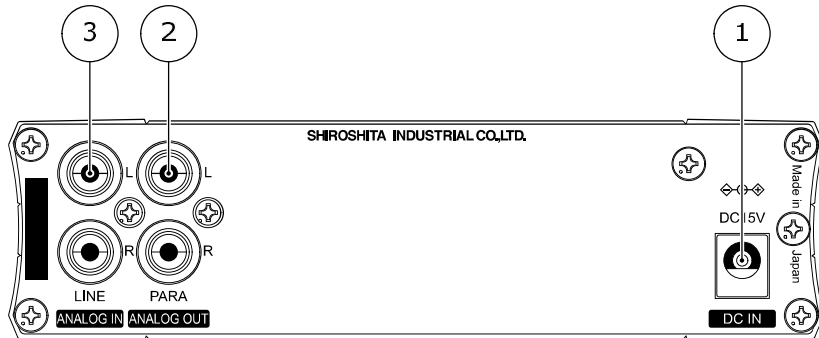

Side View

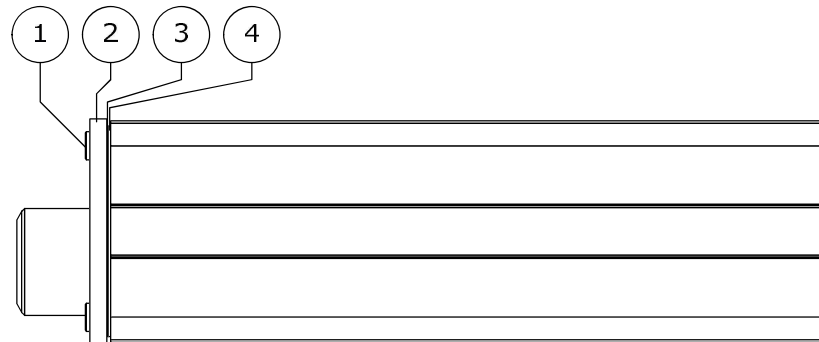

## 7 FAQs

### 7-1 Does not Turn on

Possible Factor	Solution
1 The AC adaptor is not connected properly.	1 Connect the AC adaptor properly. <b>Note:</b> Use the accompanying AC adaptor (DC15V). It does not work with DC12V.

### 7-2 No Sound or Intermittent Sound

Possible Factor	Solution
1 Problem at input devices.	1 Check if a device of sound source works properly.
2 Cables are not connected properly.	2 See "5 Connections" and connect cables properly. Check if the cables are not broken.
3 Headphones are not connected properly.	3 Check if the headphones and cables are not broken.

### 7-3 No Sound and the Power is off

Possible Factor	Solution
1 The output exceeds the maximum limit.	1 The main unit runs the protection circuit and the power may be turned off when the output exceeds the maximum limit. Turn down the volume not to exceed the limit. When it runs the protection circuit, turn on the main unit once again.

**Note:** When turned on the power with the tube cooled, the tube may light up for a moment. This is attributed to individual deference of the tubes, and it has not effect on its life duration, failure, etc.

## 6 HOW TO USE

### 6-1 Turn on Main Unit

Minimize the volume by turning off the volume control, and then press the power switch.  
The power indicator blinks for a few seconds (standby mode; no sound output) and then lights up.

### 6-2 Set up Output Gain

Set up output gain by switching gain switch. Select "LOW" when listening through headphones with impedance of 30 to 100Ω. Select "HIGH" when using headphones with 300Ω and over.

### 6-3 Listen Through Balanced Headphones

Connect balanced headphones and play back a sound source from a device connected "ANALOG IN".  
Adjust the volume by slowly turning the volume control clockwise.  
※See "5 Connections" about connecting input devices and headphones.

ONLY "HEADPHONE OUTPUT" WORKS when connecting "XLR Headphone Output" at the same time.  
Unable to listen through balanced and un-balanced headphones at the same time.

### 6-4 Listen Through Un-balanced Headphones

Connect un-balanced headphones and play back a sound source from a device connected "ANALOG IN".  
Adjust the volume by slowly turning the volume control clockwise.  
※See "5 Connections" about connecting input devices and headphones.

ONLY "HEADPHONE OUTPUT" WORKS when connecting "XLR Headphone Output" at the same time.  
Unable to listen through balanced and un-balanced headphones at the same time.

### 6-5 Turn off the Main Unit

Stop sound from a device connected to "ANALOG IN".  
Minimize the volume by turning off the volume control, and then press the power switch.

### 2-1 Front View

①		Power Switch Power Indicator	Used to turn on/off the power. Indicates the state of the power. (Not lighting up: The power is off. / Blinking: The product is in standby mode. / Lighting up: The power is on.)
②	L R	XLR Headphone Output	Used to connect balanced headphones (XLR)
③		Headphone Output	Used to connect un-balanced headphones (φ6.3 mm)
④		Gain Switch HIGH LOW	Used to switch output gain. HIGH ... For headphones with 300Ω impedance and over LOW ... For headphones from 30 to 100Ω impedance
⑤		Volume Control	Increases the volume by turning clockwise. Decreases the volume by turning counterclockwise.
⑥		Fixation Screws	Fixes the front panel.

### 2-2 Back View

①	DC IN	DC15V	Power Input	Used to input power source.
②	ANALOG OUT	PARA	RCA Parallel Output	Used to bypass volume control circuit.
③	ANALOG IN	LINE	LINE Input	Used to input analog signal.

### 2-3 Side View

①	Fixation Screws	Fixes the front panel.
②	Transparent Panel	
③	Text Sheet	Can be used either vertically/horizontally. The horizontal sheet is set as default.
④	Metal Panel	

## 3 SETTING POWER MODE

To change a power mode, unbrace the front panel and pull out a socket. Then insert it to either "Normal Mode" or "Power On Mode".

- **Normal Mode (Factory Preset)** : Switching on/off by pressing the Power switch.
- **Power On Mode** : Switching on/off by connecting/disconnecting the AC adaptor.

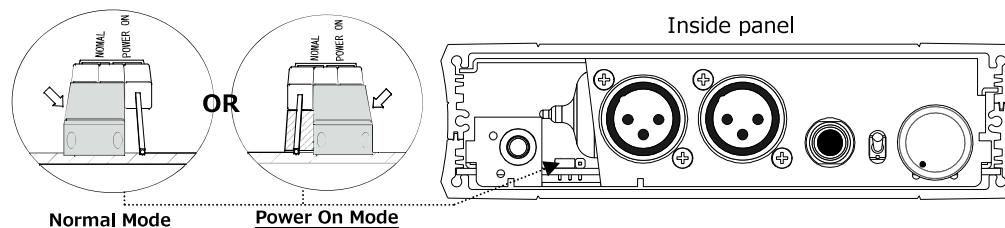

## 4 SETUP

### 4-1 Attaching the Protective Cushions

Attach the accompanying protective cushions on the bottom surface of the main unit if need be.

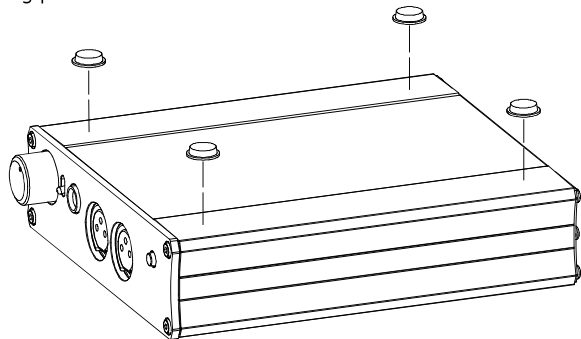

### 4-2 Changing Design of the Front Panel

Enjoy customizing the front view by changing the sheet vertically/horizontally or inserting a hand-made sheet between the text sheet and the metal panel. The fixation screws can be unbraced by the accompanying hex wrench.

- ※ When changing the sheet, take care to prevent foreign objects from entering into the main unit.
- ※ Remove protective seals both sides of the accompanying vertical sheet before using the sheet.

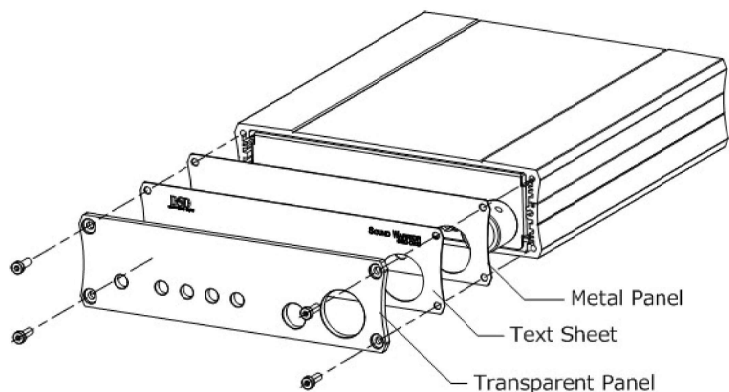

## 5 CONNECTIONS

### 5-1 ANALOG IN Connecting LINE Input

Connect a LINE output of a CD player/DA converter and the main unit with a stereo audio cable (RCA pin plugs).

### 5-2 ANALOG OUT Connecting RCA Parallel Output

Connect a LINE input of a power amplifier and the main unit with a stereo audio cable (RCA pin plugs).  
\*No need to connect when using a power amplifier.

### 5-3 L R Connecting Balanced Headphones

Connect balanced headphones to L and R of the XLR Headphone Output.

### 5-4 Connecting Un-balanced Headphones

Connect un-balanced headphones with 6.3 mm plug to the Headphone Output.

\*ONLY "HEADPHONE OUTPUT" WORKS when connecting "XLR Headphone Output" at the same time.

### 5-5 DC IN Connecting Power Input

Minimize the volume by turning off the volume control. Connect the accompanying AC adaptor and the AC cord together, and then connect it to the main unit.

