

"DSD" is a registered trademark, "Direct Stream Digital", DSD and their logos are trademarks of Sony Corporation.

**DSD**  
Direct Stream Digital

# SOUNDWARRIOR

High Resolution USB D/A Converter

## SWD-DA20

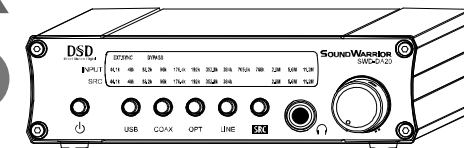

# User Guide

SOUND WARRIOR's High Resolution D/A Converter Supports PCM Playback (Up to 768kHz/32bit) & DSD Playback (Up to 11.2MHz)

## Table of Contents

<b>1 IMPORTANT SAFEGUARDS</b> .....	2	<b>5 CONNECTING INPUTS</b> .....	24
1-1 Safety Graphic Symbols.....	2	5-1 Listening to PC Audio Source via USB Input.....	24
1-2 Warning.....	2	5-2 Listening via Coaxial Input.....	25
1-3 Caution.....	3	5-3 Listening via Optical Input.....	25
1-4 Accessories.....	3	5-4 Listening via Analog Input.....	25
<b>2 PART NAMES AND FUNCTIONS</b> .....	4	<b>6 CONNECTING OUTPUTS</b> .....	26
2-1 Front Panel Functions.....	4	6-1 Listening through Speakers.....	26
2-2 Side View.....	5	6-2 Listening through Headphones.....	26
2-3 Inside Panel.....	6	6-3 Adjusting Volume.....	26
2-4 Rear Panel Functions.....	7	<b>7 SAMPLING RATE &amp; FORMAT</b> .....	27
<b>3 CONNECTIONS</b> .....	8	7-1 BYPASS Mode.....	27
3-1 ANALOG OUT : Connecting LINE Output.....	8	7-1-1 Display in BYPASS Mode.....	27
3-2  : Connecting Headphone Output.....	8	7-1-2 Switch to BYPASS Mode.....	27
3-3 ANALOG IN : Connecting LINE Input.....	8	7-2 SRC Mode.....	27
3-4 DIGITAL IN : Connecting Optical Input.....	8	7-2-1 Display in SRC Mode.....	27
3-5 DIGIATL IN : Connecting Coaxial Input.....	8	7-2-2 How to use SRC mode.....	28
3-6 DIGIATL IN : Connecting USB Input.....	8	7-2-3 Table of Input Sampling Rate and Up-sampled Output.....	29
3-7 CLOCK IN : Connecting Word Clock Input.....	8	7-3 EXT Mode (External Synchronization).....	29
3-8 DC IN : Connecting Power Source.....	8	<b>8 CONNECTING EXTERNAL WORD CLOCK</b> .....	30
<b>4 PC SETUP</b> .....	10	8-1 Clocking External Clock.....	30
4-1 System Requirement.....	10	8-1-1 Display in EXT Mode.....	30
4-2 Installing Driver (Windows®).....	11	8-1-2 How to Use EXT mode.....	30
4-3 Installing foobar2000.....	14	8-2 Table of Input Sampling Rate & Frequency of External Clock...30	
4-3-1 Installing ASIO Proxy.....	14	<b>9 CUSTOMIZATION</b> .....	31
4-3-2 Installing foobar2000.....	17	9-1 Attaching Protective Cushions.....	31
4-3-3 Adding Components.....	19	9-2 Changing Design of Front Panel.....	31
4-4 Setting Up foobar2000.....	21	<b>10 TROUBLESHOOTING</b> .....	32
4-4-1 Setting Up foobar2000.....	21	<b>11 WARRANTY INFORMATION</b> .....	34
		<b>12 TECHNICAL SPECIFICATIONS</b> .....	35

# SOUNDWARRIOR

**SHIROSHITA** SHIROSHITA  
INDUSTRIAL  
城下工業株式会社 CO.,LTD.

1-1-58 Tokiiri, Ueda, Nagano, 386-0015 JAPAN  
Email: [userinfo@shiroshita.com](mailto:userinfo@shiroshita.com)  
<http://www.shiroshita.com/e/>

 **Facebook**  
<https://www.facebook.com/SoundWarrior.jp>

 **Twitter**  
[https://twitter.com/SoundWarrior\\_jp](https://twitter.com/SoundWarrior_jp)



Printed in Japan  
18QA0315B5

Thank you for purchasing SWD-DA20US, "High Resolution USB D/A Converter".  
**READ AND FOLLOW ALL SAFETY INSTRUCTIONS BEFORE USING THE PRODUCT.**  
**KEEP THE USER GUIDE WITH A WARRANTY CARD FOR FUTURE REFERENCE.**



## 1 IMPORTANT SAFEGUARDS

### 1-1 Safety Graphic Symbols







The following symbols are used to define the degree of danger when abused and misused the product.

	<b>WARNING</b>	.....	Negligence of the instructions may lead to mishandling that may cause death or serious injury.
	<b>CAUTION</b>	.....	Negligence of the instructions may lead to mishandling that may cause a minor injury, property or financial damage.

The following symbols are used to indicate the actions that should be followed.

	.....	This symbol indicates actions that call users' attention.
	.....	This symbol indicates prohibited actions that must not be performed.
	.....	This symbol indicates compulsory actions that must be performed.

### 1-2 WARNING

<b>1-2-1</b>		In the following cases, immediately turn off the power switch and disconnect the AC adapter from the power outlet. Then contact us for repair. <ul style="list-style-type: none"> <li>● Smoke, strange odor or strange sound.</li> <li>● Damaged elements or cables.</li> <li>● Penetration of liquids or foreign objects, or the like.</li> </ul>
<b>1-2-2</b>		Do not prevent the product from releasing the heat by covering with a cloth, etc. Do not place the product in a stuffy room, narrow room or the like. This could result in fire.
<b>1-2-3</b>		Do not use the product outdoors, in a bathroom or the like. Penetration of liquids or foreign objects could result in fire or electrical shock. If liquids or foreign objects should enter the product, immediately disconnect the AC adapter from the power outlet and contact us for repair.
<b>1-2-4</b>		Never disassemble and modify. Modification and/or disassembly of the product or accessories could result in fire or electrical shock. Contact us for repair.
<b>1-2-5</b>		Do not use except the supplied AC adapter. Do not use over the rated voltage.
<b>1-2-6</b>		Do not place anything on the product or cover it with a cloth, etc. Do not place anything on the cords or damage it. This could result in fire or electrical shock.

## 1 2 Technical Specifications

### General

Power Supply	AC100 - 240V 50/60Hz (AC adapter), DC12V - 15V (Main Unit)
Power Consumption	8W
Operating Temperature	0 - 40°C
External Dimensions	W145.4 × H40 × D165 mm (Protruding part not included)
Weight	Approx. 0.7kg

### Digital Input

Connector	Optical: TOS-Link connector, Coaxial: RCA pin jack
Signal Standard	S/PDIF
Sampling Rate	44.1k / 48k / 88.2k / 96k / 176.4k / 192kHz
Quantization Bit Rate	16 / 24bit

### Digital Input (USB)

Connector	USB Type B (USB2.0)
Operating System	Windows® 7(Latest) / Windows® 8 / Windows® 8.1 / Windows® 10 Mac® OS X® 10.8 / OS X® 10.9 / OS X® 10.10 / OS X® 10.11 / macOS™ 10.12
PCM Transfer Method	Isochronous Transfer: Asynchronous Transfer Mode
PCM Sampling Rate	44.1k / 48k / 88.2k / 96k / 176.4k / 192k / 352.8k / 384k / 705.6k / 768kHz
PCM Quantization Bit Rate	24 / 32bit
DSD Transfer Method	Isochronous transfer: Asynchronous Transfer Mode (DoP, ASIO Native)
DSD File Format	DSF(.dsf) / DSDIFF(.dff)
DSD Sampling Rate	2.8224M / 5.6448M / 11.2896MHz

### Word Clock Input

Connector	75Ω BNC jack
Frequency (Word Clock)	44.1k / 48k / 88.2k / 96k / 176.4k / 192k / 352.8k / 384kHz
Frequency (Super Clock)	5.6448M / 6.144M / 11.2896M / 12.288M / 22.5792M / 24.576M / 45.1584M / 49.152MHz
Input Level	5Vp-p

### Analog Input (LINE)

Connector	RCA pin jack
-----------	--------------

### Analog Output (LINE)

Connector	RCA pin jack
Max. Output: FIXED	+9.0dBm (2.2Vrms) at full-scale input
VARIABLE	+9.0dBm (2.2Vrms) at full-scale input and volume

### Analog Output (PHONES)

Connector	6.3mm stereo jack
Max. Output	60mW + 60mW (at 40Ω)

Design and specifications are subject to change without notice.  
 DSD and their logos are trademarks of Sony Corporation.  
 Microsoft and Windows are either registered trademarks or trademarks of Microsoft Corporation in the United States and/or other countries.  
 Mac and OS X are registered trademarks of Apple Inc.  
 macOS is trademarks of Apple Inc.

## 1 1 WARRANTY INFORMATION

We offer a 1 year limited warranty for repair from the original purchase date.

### In-Warranty Repairs

We will check if the failure is covered by the warranty with the information below. Prepare it and the warranty card, and contact us via [userinfo@shiroshita.com](mailto:userinfo@shiroshita.com).

- Name
- Email Address
- Postal Address
- Name of the Product (SWD-DA20US)
- Serial Number
- Situation and details when the failure occurred.

### Out-of-Warranty Repairs

We also provide a repair quotation for out-of-warranty repair. Contact us via [userinfo@shiroshita.com](mailto:userinfo@shiroshita.com).

1-2-7  Clean the power plug periodically with a soft and dry cloth. Accumulated dust could result in fire.

1-2-8  Do not touch the product, the connected devices, the connecting cords, the AC adapter, etc. during a lightning storm. This could result in electrical shock.

### 1-3 CAUTION

1-3-1  Do not place the product on an unstable surface. This could result in falling and cause an injury. Place the product away from walls and other devices to release heat sufficiently.

1-3-2  Do not place the product in the following places. This could result in fire or electrical shock.

- Highly humid or dusty places.
- Places with smoke or oily smoke. (A kitchen, a humidifier or the like)

1-3-3  Place the product vertically or horizontally on a stable surface.

1-3-4  Do not touch the AC adapter with a wet hand. This could result in electrical shock. Do not pull the cord when disconnected. Hold the plug and disconnect. Disconnect the AC adapter from the power outlet when not used for a long time.

1-3-5  Disconnect the AC adapter from the power outlet when cleaning. Use a dry cloth to clean the product. Do not use thinner, alcohol or the like.

1-3-6  Turn the volume down before turning on the product. The loud sound could result in hearing impairment or failure of the product.

### 1-4 Accessories

- |                                 |    |                      |    |
|---------------------------------|----|----------------------|----|
| ● AC adapter                    | ×1 | ● Protective cushion | ×4 |
| ● Setup CD                      | ×1 | ● User Guide         | ×1 |
| ● Text sheet for vertical setup | ×1 | ● Warranty Card      | ×1 |
| ● Hex key                       | ×1 |                      |    |

## 2 PART NAMES AND FUNCTIONS

### 2-1 Front Panel Functions

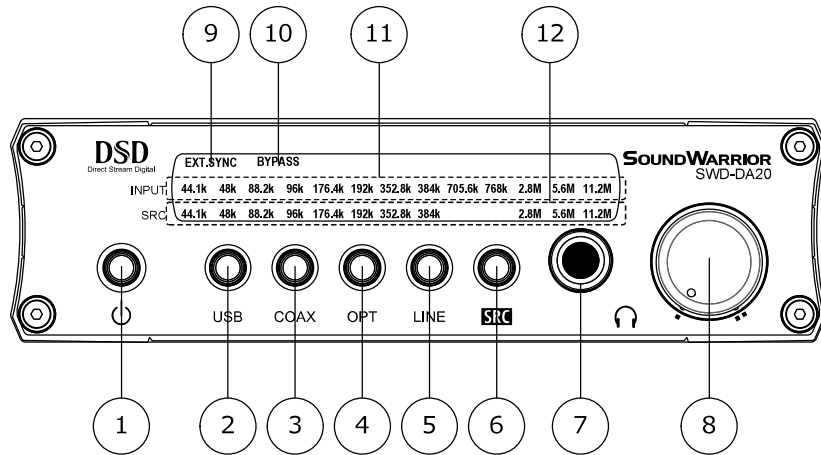

①	Power Switch	Used to turn on/off the power.
	Power Indicator	This lights up while the power is on.
②	USB Switch	Used to select the USB input. Each press of the switch changes between the BYPASS mode and the SRC mode.
	USB Indicator	This lights up while the USB input is selected and recognized by PC properly. This blinks slowly when not recognized by PC properly. This blinks quickly when frequency of an external word clock is improper.
③	COAX Coaxial Switch	Used to select the coaxial input. Each press of the switch changes between the BYPASS mode and the SRC mode.
	Coaxial Indicator	This lights up while the coaxial input is selected and the digital audio signal is recognized properly. This blinks slowly when a digital audio signal is not recognized properly. This blinks quickly when frequency of an external word clock is improper.
④	OPT Optical Switch	Used to select the optical input. Each press of the switch changes between the BYPASS mode and the SRC mode.
	Optical Indicator	This lights up while the optical input is selected and the digital audio signal is recognized properly. This blinks slowly when the digital audio signal is not recognized properly. This blinks quickly when frequency of an external word clock is improper.

### #7: PC not Recognize SWD-DA20US

Possible Factor	Solution
1 USB port stopped responding.	1-1 Disconnect the USB cable and connect it again. 1-2 Disconnect the USB cable and connect it after restarting a PC and the main unit. 1-3 Connect the USB cable to other USB port.
2 Driver has not been installed properly.	2-1 Disconnect the main unit from a PC and uninstall the driver. After restarting a PC, install the driver again. 2-2 Update Windows®7 OS to the latest version via Windows Update.

Please note that it may not operate correctly depending on your environment even if used properly.

### #8: Errors on foobar2000

When an error occurs and cannot play back audio source, check the following instructions.

Error	Possible Factor	Solution
Unable to open item for playback (Object not found): " (File Name)"	Audio source is missing and unable to access.	Restore deleted audio source or delete tracks from playlist.
Unable to open item for playback (I/O error):" (File Name)"	Unable to access to audio source.	Check the connection to an external HDD or a media that audio source is stored.
Unable to open item for playback (Unsupported format or corrupted file): Unrecoverable playback error: (Sample rate) Hz not supported by this device	"foo_input_sacd" has not been installed.	Install "foo_input_sacd".
Unrecoverable playback error: Could not create ASIO buffers	Other application is playing back audio source.	Stop sound/video playback from other media players.
Unrecoverable playback error: Could not locate the specified virtual ASIO device	ASIO Proxy has not been installed.	Install ASIO Proxy.
Unrecoverable playback error: Could not start ASIO playback	External word clock has not properly inputed.	Check the connection of external word clock.
Unrecoverable playback error: Invalid device	The main unit has not been recognized from a PC.	Check the connection of a USB cable.

## 1 0 TROUBLESHOOTING

### #1: Does not Turn on

Possible Factor	Solution
1 The AC adaptor is not connected properly.	1 Connect the AC adaptor properly.

### #2: Power Indicator Blinks Quickly

Possible Factor	Solution
1 Malfunction of word clock.	1 Disconnect the external word clock, and turn off and on the product. It is still not solved, contact us for repair.

### #3: EXT.SYNC Indicator Blinks

Possible Factor	Solution
1 Frequency of an external clock is improper.	1-1 Supply an external clock which complies with input sampling rate. Please see "8-2 Table of Input Sampling Rate & Frequency of External Clock" for more information.

### #4: OPT/COAX Indicator Blinks

Possible Factor	Solution
1 Cables are not connected properly.	1 Connect optical/coaxial cables properly. Check if the cables are not broken.
2 Audio source or setting is not appropriate.	2-1 Check if a device of audio source works properly. 2-2 Check if an input signal is S/PDIF. 2-3 Check if sampling rate of an input signal is correct.

### #5: USB Indicator Blinks

Possible Factor	Solution
1 USB connection is not appropriate.	1 Connect to a USB 2.0/3.0 port on your PC.

### #6: Unable to Install Driver Properly

Possible Factor	Solution
1 The OS is not updated. (For Windows®7 Users Only)	1 Update Windows®7 OS to the latest version via Windows Update.

⑤ LINE	LINE Switch	Used to select the LINE input.
	LINE Indicator	This lights up while the LINE input is selected.
⑥ SRC	SRC Switch	Used to select sampling rate in the built-in sampling rate converter (SRC) mode. Used to select the SRC mode while the BYPASS mode is selected. Each press of the switch increases the sampling rate. This decreases sampling rate while holding down the switch.
	Headphone Output	Used to output an audio signal to headphones.
⑧	Volume Control	Used to control the headphone volume. When "VARIABLE" is selected on the rear panel, this also controls the LINE output signal.
⑨	EXT.SYNC Indicator	This lights up while an external word clock is detected. While the light is on, it clocks with an external word clock.
⑩	BYPASS Indicator	This lights up while the BYPASS mode is selected.
⑪	INPUT Indicator	This indicates sampling rate of a digital audio input.
⑫	SRC Indicator	This indicates converted sampling rate while the SRC mode is selected.

## 2-2 Side View

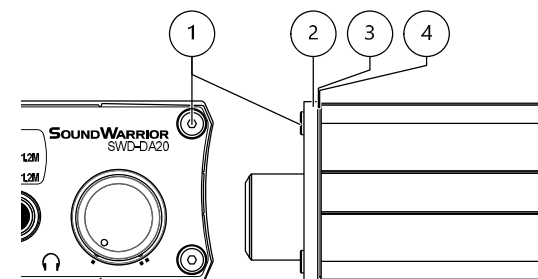

① Fixing Screws	These fix the front panel. Use the supplied hex key to detach the panel.
② Transparent Panel	
③ Text Sheet	Used for either vertical/horizontal setup. The horizontal sheet is set as default.
④ Metal Panel	

2-3 Inside Panel

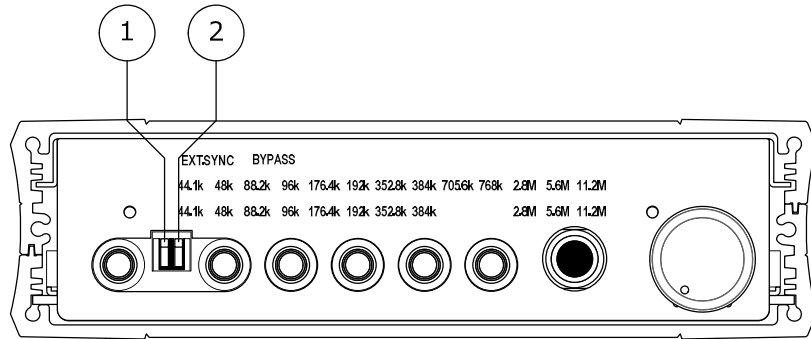

- |     |              |  |
|-----|--------------|--|
| ① 1 | Switch #1 ※1 | Used to set up how to turn on/off the power.<br>UP: Turn on/off with the "Power Switch" on the front panel.<br>(Factory setting)<br>DOWN: Turn on the power when connected the AC adapter.<br>Turn off the power when disconnected the AC adapter. |
| ② 2 | Switch #2    | Not in Use   |

※ Detach the front panel when set up the Switch #1.

9 CUSTOMIZATION

9-1 Attaching Protective Cushions

Attach the supplied protective cushions on the bottom surface of the main unit if need be.

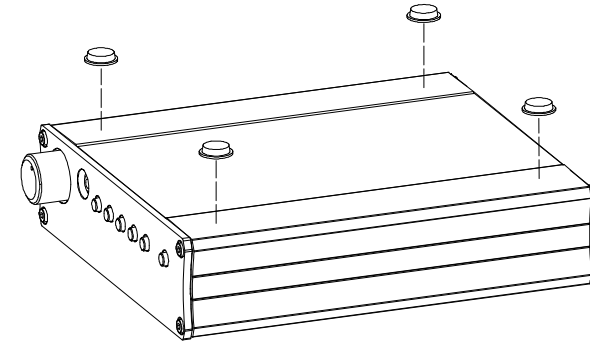

9-2 Changing Design of Front Panel

Enjoy customizing the front panel by changing the text sheet vertically/horizontally or inserting a self-build sheet between the text sheet and the metal panel. The fixation screws can be unbraced by the supplied hex key.

- ※ When changing the sheet, take care to prevent foreign objects from entering into the main unit.
- ※ Remove protective seals both sides of the supplied vertical text sheet before using the sheet.
- ※ Do not drive screws too tightly. This could result in breaking the front panel, etc.

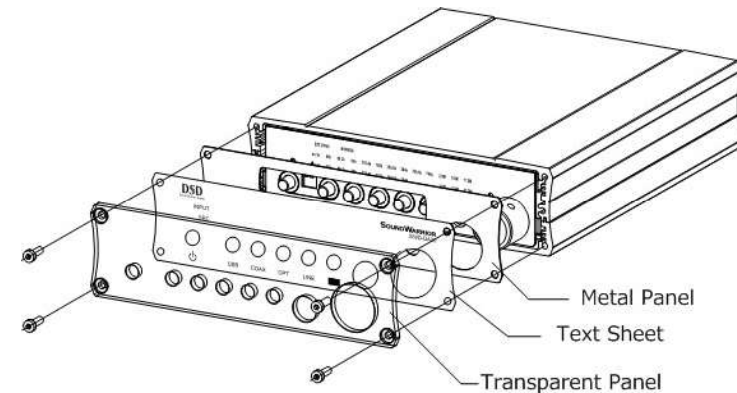

## 8 Connecting External Word Clock

Enjoy remarkable audio quality by inputting word clock or super clocks 128x/256x from a clock generator. Please note that it is unable to up-sample when connected to an external clock.

### 8-1 Clocking External Clock

#### 8-1-1 Display in EXT Mode

The BYPASS indicator will be turned off and the EXT.SYNC indicator lights up. Even if the EXT.SYNC indicator lights up, the BYPASS mode is on while BYPASS indicator lights up.

If frequency of an external clock is improper, the EXT.SYNC indicator blinks and no sound is output.

#### 8-1-2 How to Use EXT mode

##### 1 Connect with a Clock Generator

Connect the "CLOCK IN" of the main unit and a clock output plug of a clock generator. Please note that a BNC cable (75Ω) is not supplied. "CLOCK IN" is terminated at 75Ω, and do not connect a termination resistor.

Please see "8-2 Table of Input Sampling Rate & Frequency of External Clock" for information on frequency of external clock.

##### 2 Switch to EXT Mode

Each press of the switches of the selected input (USB/COAX/OPT) changes between the EXT mode and the BYPASS mode.

### 8-2 Table of Input Sampling Rate & Frequency of External Clock

Sampling Rate	Word clock able to input		Super clock able to input	
	176.4 kHz	352.8 kHz	22.5792 MHz	45.1584 MHz
44.1 kHz	44.1 kHz		5.6448 MHz	11.2896 MHz
48 kHz	48 kHz		6.144 MHz	12.288 MHz
88.2 kHz	88.2 kHz		11.2896 MHz	22.5792 MHz
96 kHz	96 kHz		12.288 MHz	24.576 MHz
176.4 kHz	176.4 kHz		22.5792 MHz	45.1584 MHz
192 kHz		192 kHz	24.576 MHz	49.152 MHz
352.8 kHz	176.4 kHz	352.8 kHz		45.1584 MHz
384 kHz	192 kHz	384 kHz		49.152 MHz
DSD 2.8 MHz	176.4 kHz	352.8 kHz	22.5792 MHz	45.1584 MHz
DSD 5.6 MHz	176.4 kHz	352.8 kHz	22.5792 MHz	45.1584 MHz
DSD 11.2 MHz	176.4 kHz	352.8 kHz		45.1584 MHz

### 2-4 Rear Panel Functions

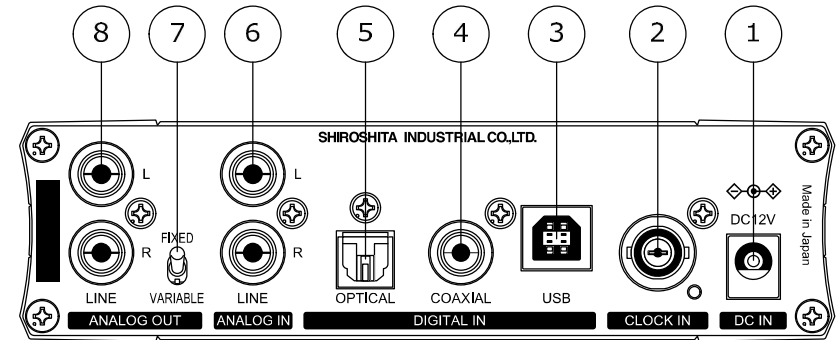

① DC IN	Power Input (DC12V)	Used to connect the supplied AC adapter.
② CLOCK IN	External Word Clock Input	Used to input a word clock/super clock.
③ DIGITAL IN	USB Input	Used to input a USB signal.
④ DIGITAL IN	Coaxial Input	Used to input a coaxial (S/PDIF) signal.
⑤ DIGITAL IN	Optical Input	Used to input an optical (S/PDIF) signal.
⑥ ANALOG IN	LINE Input	Used to input an analog signal.
⑦ ANALOG OUT	Analog Output Switch (FIXED/VARIABLE)	FIXED : Output level from the LINE output will be fixed. VARIABLE : Output level from the LINE output will be variable. Use the volume control to adjust the volume. ※ Output level from the Headphone Output is always variable. It is unable to set at a fixed level!
⑧ ANALOG OUT	LINE Output	Used to output an analog signal.

### 3 CONNECTIONS

Please note that audio cables are not supplied.

#### 3-1 ANALOG OUT : Connecting LINE Output

Used to output an analog audio signal.  
Connect a LINE input of a speaker/power amplifier and the main unit with a stereo audio cable (RCA pin plugs).

#### 3-2 : Connecting Headphone Output

Used to output an analog audio signal to headphones.  
Connect a headphone (6.3mm stereo plug). Please note that an adaptor 3.5mm to 6.3mm is not supplied.

#### 3-3 ANALOG IN : Connecting LINE Input

Used to input an analog audio signal.  
Connect a LINE output of a CD player, a cassette deck, etc. and the main unit with a stereo audio cable (RCA pin plugs).

#### 3-4 DIGITAL IN : Connecting Optical Input

Used to input a digital audio signal(S/PDIF).  
Connect an optical output of a CD player, a PC, etc. and the main unit with an optical cable (Square TOS-Link).

#### 3-5 DIGIATL IN : Connecting Coaxial Input

Used to input a digital audio signal(S/PDIF).  
Connect a coaxial output of a CD transport, etc. and the main unit with a coaxial cable (RCA pin plugs).

#### 3-6 DIGIATL IN : Connecting USB Input

Used to input audio signal from a PC.  
Connect a PC USB and the main unit with a USB 2.0 cable. If using Windows PC, install a driver from the supplied setup CD.

#### 3-7 CLOCK IN : Connecting Word Clock Input

Used to input an external word clock. The main unit is synchronized with an external word clock, and performs sampling rate conversion and digital to analog conversion.  
Connect a word clock output of a clock generator and the main unit with a BNC cable. Please see "8 Connecting External Word Clock" for a usable external clock.

#### 3-8 DC IN : Connecting Power Source

Used to input power supply.  
Connect the supplied AC adapter and the main unit.

### 7-2-3 Table of Input Sampling Rate and Up-sampled Output

Input Sampling Rate \ Up-sampled Output	44.1k	48k	88.2k	96k	176.4k	192k
44.1 kHz	×	○	○	○	○	○
48 kHz	×	×	○	○	○	○
88.2 kHz	×	×	×	○	○	○
96 kHz	×	×	×	×	○	○
176.4 kHz	×	×	×	×	×	○
DSD 2.8 MHz	○	○	○	○	○	○
DSD 5.6 MHz	○	○	○	○	○	○
DSD 11.2 MHz	○	○	○	○	○	○

Input Sampling Rate \ Up-sampled Output	352.8k	384k	DSD 2.8M	DSD 5.6M	DSD 11.2M
44.1 kHz	○	○	○	○	×
48 kHz	○	○	○	○	×
88.2 kHz	○	○	○	○	△
96 kHz	○	○	○	○	△
176.4 kHz	○	○	○	○	○
192 kHz	○	○	○	○	○
352.8 kHz	×	○	○	○	○
384 kHz	×	×	○	○	○
705.6 kHz	×	×	○	○	○
768 kHz	×	×	○	○	○
DSD 2.8 MHz	○	○	×	○	○
DSD 5.6 MHz	○	○	×	×	○
DSD 11.2 MHz	○	○	×	×	×

○ : Able to select by pressing the SRC switch  
△ : Not recommended to select  
× : Unable to select

### 7-3 EXT Mode (External Synchronization)

Used to synchronize with an external clock from a clock generator. Please see "8 Connecting External Word Clock".

Please note that it is unable to up-sample when connected to an external clock. ( **SRC** switch is invalid.)



## 7-2-2 How to use SRC mode

### 1 Switch to SRC Mode

Each press of the switches of the selected input (USB/COAX/OPT) changes between the SRC mode and the BYPASS mode.

Press of the **SRC** switch in the BYPASS mode also selects the SRC mode.

### 2 Select Sampling Rate

Each press of the **SRC** switches changes sampling rates as below.

44.1k → 48k → 88.2k → 96k → 176.4k → 192k → 352.8k → 384k → 2.8M → 5.6M → 11.2M

※ Please note that the sampling rate less than or equal to the input sampling rate is unable to be selected.

It changes sampling rates as below while holding down the **SRC** switch.

44.1k → 11.2M → 5.6M → 2.8M → 384k → 352.8k → 192k → 176.4k → 96k → 88.2k → 48k

※ Please note that the sampling rate less than or equal to the input sampling rate is unable to be selected.

※ Keep holding down the **SRC** switch to change sampling rates consecutively.

### Converting to DSD 11.2M

Play back an audio source more than or equal to 176.4k when converted PCM to DSD11.2M. An audio source less than 176.4k may not be played back properly. Also, please note that it is unable to convert 44.1k/48k to DSD11.2M.

※ It automatically switches to the BYPASS mode when input sampling rate changed.

Even if input sampling rate not changed, it automatically switches to the BYPASS mode by skipping DSD music on audio player software which "DoP" is selected. Select "ASIO Native" to make it occur less frequently. Please see "4-4-1 Setting Up foobar2000" step 4.

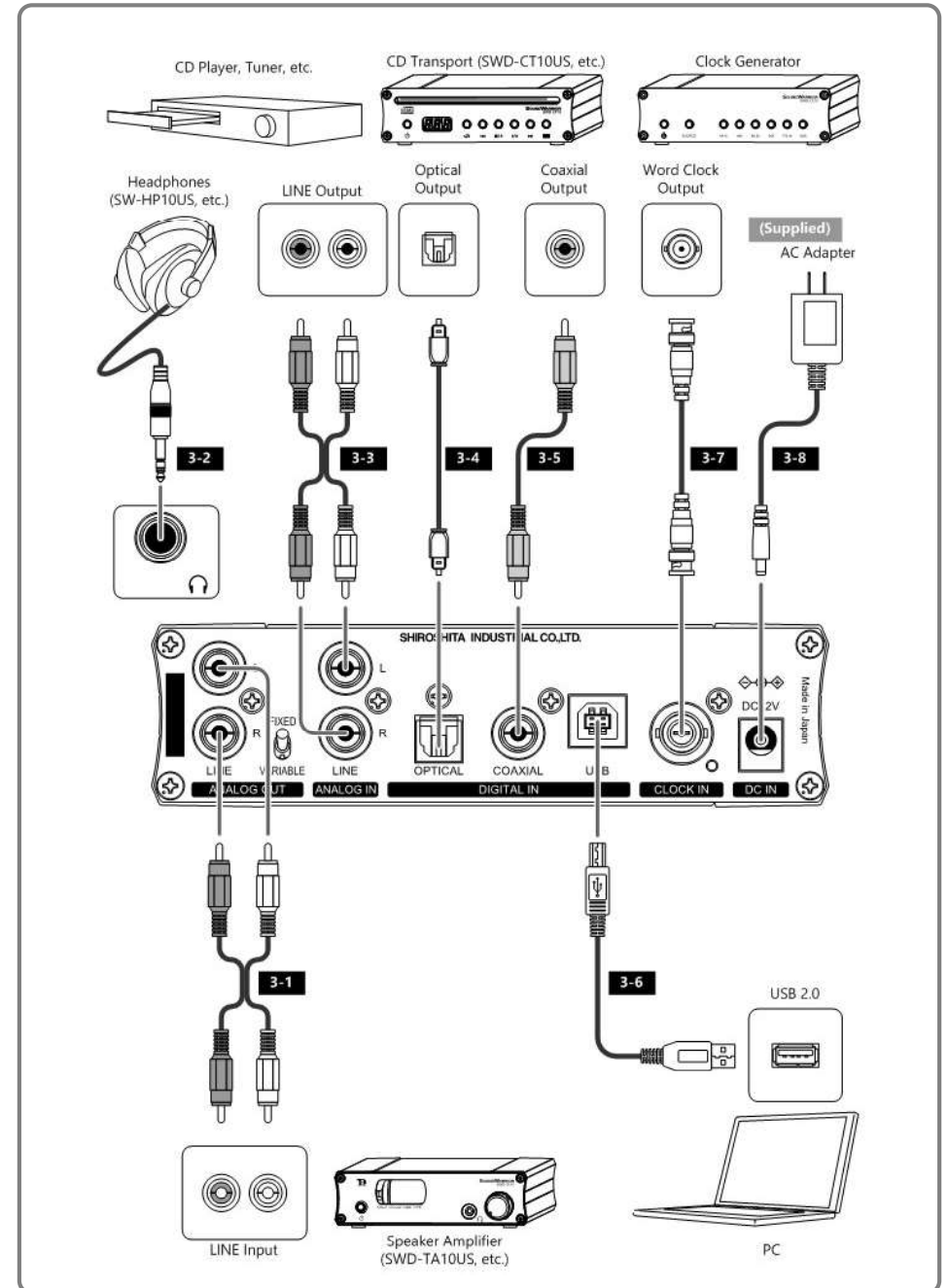

## 4 PC SETUP

### ● For Windows® Users

Install a driver when connecting the main unit and a Windows® PC with USB. Also, install audio player software which supports the high-resolution PCM and the DSD playback when listening to those audio sources. Install them from setup assist program (SwdAssist2) in the supplied setup CD.

### ● For Mac® Users

No driver is required when using SWD-DA20US with a Mac®. Install audio player software which supports the hi-resolution PCM and the DSD playback when listening to those audio sources.

### 4-1 System Requirement

#### Windows®

Use a PC that meets the system requirement below. Please note that it may not operate properly depending on your environment even if used on the required system below.

Operating System	Microsoft® Windows® 7, Windows® 8, Windows® 8.1, Windows® 10
USB	USB2.0, USB3.0

※ As for Windows® 7, the update March 2015 is required.

#### Mac®

Use a PC that meets the system requirement below. Please note that it may not operate properly depending on your environment even if used on the required system below.

Operating System	OS X® 10.8, OS X 10.9, OS X 10.10, OS X 10.11, macOS 10.12
USB	USB2.0, 3.0

- ※ No driver is required for Mac®.
- ※ Please note that it may not operate properly when upgraded to a higher version than the versions listed above.

NOTE: Before connecting the SWD-DA20US to your computer, please complete the installation of the driver by following the instructions below.

## 7 Sampling Rate & Format

The SWD-DA20US is equipped with the "SRC" (Sampling Rate Converter) function to up-sample an audio source or mutually convert between PCM and DSD. Enjoy selecting one of many PCM(44.1kHz-768kHz) and DSD(2.8M-11.2MHz) sampling rates, and converting a playing PCM signal to a DSD signal and vice versa.

※Some of the sampling rates you can select are restricted.

### 7-1 BYPASS Mode

Used to bypass the SRC function and perform D-A conversion of input digital signal. No sampling rate and the format will be changed.

#### 7-1-1 Display in BYPASS Mode

The BYPASS indicator lights up while the BYPASS mode is selected.

#### 7-1-2 Switch to BYPASS Mode

Each press of the switches of the selected input (USB/COAX/OPT) changes between the BYPASS mode and the SRC mode (or EXT mode).

### How to play back an audio source with 705.6k/768k sampling rate

Convert an audio source with 705.6k/768k sampling rate into DSD when played back. Playback of the audio with the 705.6k/768k is not supported by the SWD-DA20US.

### 7-2 SRC Mode

Used to be routed through the SRC function and perform D-A conversion of input digital signal. It up-samples a PCM/DSD audio source or mutually converts between PCM and DSD.

When an appropriate external clock is supplied, the EXT mode (External synchronization mode) will be selected. Stop supplying an external clock when selecting the SRC mode.

#### 7-2-1 Display in SRC Mode

The BYPASS indicator and the EXT.SYNC indicator will be turned off. It up-samples an audio source to the sampling rate selected on the SRC indicator.

44.1k - 384k..... Showing that it up-samples to the selected sampling rate (PCM).

2.8M - 11.2M..... Showing that it up-samples to the selected sampling rate (DSD).

※ 2.8M = 2.8224MHz(DSD), 5.6M = 5.6448MHz(DSD), 11.2M = 11.2896MHz(DSD)

## 6 Connecting Outputs

### 6-1 Listening through Speakers

#### Connecting to a power amplifier

Connect a LINE input of a power amplifier, a speaker amplifier, etc. and "ANALOG OUT - LINE" of the main unit with a stereo audio cable (RCA pin plugs). Please note that a stereo pin cable (RCA cable) is not supplied.

### 6-2 Listening through Headphones

#### Connecting headphones

Connect a headphone (6.3mm stereo plug) to the "PHONES OUT" of the main unit. Please note that an adaptor 3.5mm to 6.3mm is not supplied.

### 6-3 Adjusting Volume

#### Fixed Level Output

When "FIXED" of the Analog Out Switch is selected, it outputs sound with fixed level from the LINE Output. The Volume Control does not work when "FIXED" is selected. The Headphone Output is unable to output fixed level sound. Adjust volume by the Volume Control.

#### Variable Level Output

When "VARIABLE" of the Analog Out Switch is selected, the output level of the LINE Output is adjustable by the Volume Control.

## 4-2 Installing Driver (Windows®)

Insert the supplied setup CD into a PC and install a driver by following the instructions below. Please see the online manual in the setup CD for more detailed information.

Download the driver from the following "SOUND WARRIOR" website if using a Windows tablet or a PC without an optical disc drive.

<http://www.shiroshita.com/sw/>

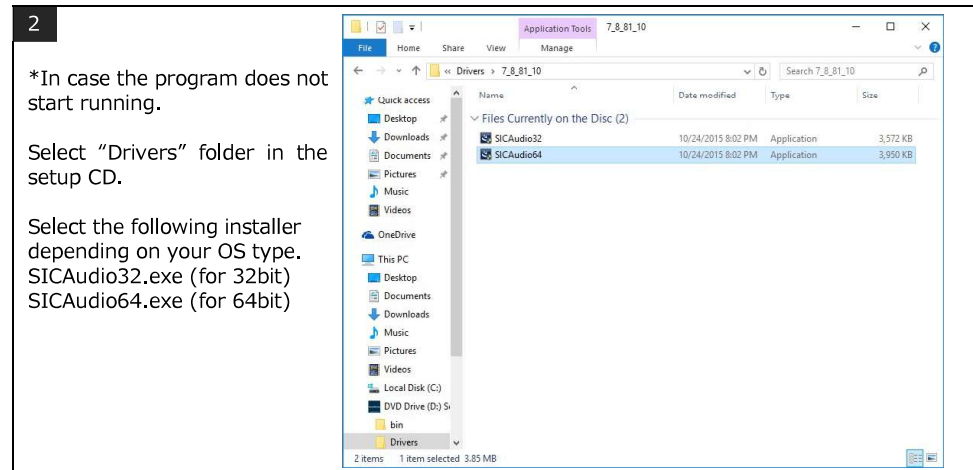
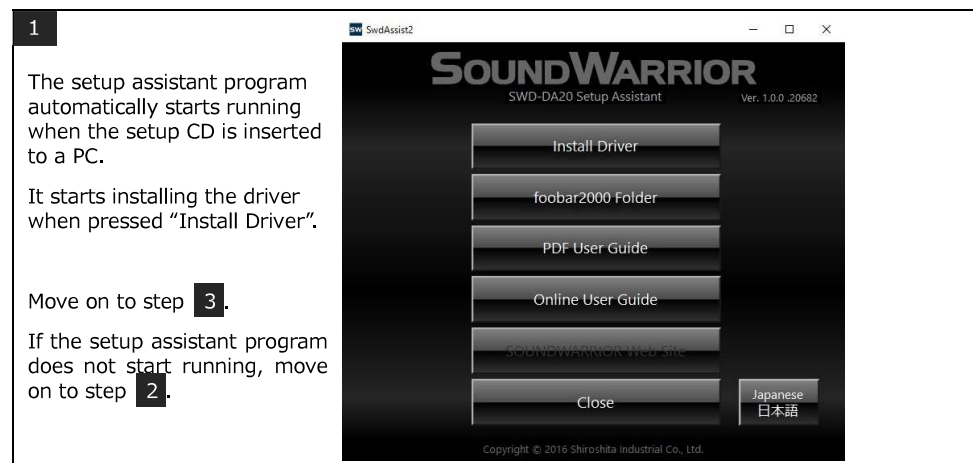

**3**

Click "Yes".



**4**

Select "English (United States)" and click "OK".

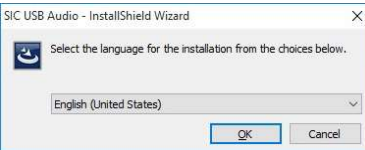

**5**

Click "Next >".



**6**

Click "Install".



## 5-2 Listening via Coaxial Input

### 1 Connecting with a coaxial cable

Connect a coaxial output of a CD player, a MD player, etc. and the "DIGITAL IN - Coaxial Input" of the main unit with a coaxial cable. Please note that a coaxial cable is not supplied.

### 2 Press "COAX" in the front panel

Press "COAX" switch to select coaxial input. When the signal is being received properly, the coaxial indicator lights up. When no/wrong signal is being received, the indicator blinks slowly.

## 5-3 Listening via Optical Input

### 1 Connecting with an optical cable

Connect an optical output of a CD player, a MD player, etc. and the "DIGITAL IN - Optical Input" of the main unit with an optical cable. Please note that an optical cable (TOS-Link cable) is not supplied.

### 2 Press "OPT" in the front panel

Press "OPT" switch to select optical input. When the signal is being received properly, the optical indicator lights up. When no/wrong signal is being received, the indicator blinks slowly.

## 5-4 Listening via Analog Input

### 1 Connecting with a stereo pin cable

Connect a LINE output of a CD player, a cassette deck, etc. and "ANALOG IN - LINE Input" of the main unit with a stereo audio cable (RCA pin plugs). Please note that a stereo pin cable (RCA cable) is not supplied.

### 2 Press "LINE" in the front panel

Press "LINE" switch to select LINE input. When selected, the LINE indicator lights up.

## 5 Connecting Inputs

### 5 - 1 Listening to PC Audio Source via USB Input

**1] Install a driver (When used for the first time)**

Before connecting a Windows® PC for the first time, the driver needs to be installed. Install the driver from the supplied setup CD. Please see “4 PC SETUP” for detail. No driver is needed for Mac®.

**2] Connect to a PC with a USB cable**

Connect the main unit and a PC.  
Please note that a USB cable is not supplied. Use a cable supports USB2.0 and a cable within 1 meter long.

**3] Press “USB” in the front panel**

Press “USB” switch to select USB input. When properly connected to a PC, the USB indicator lights up. When not recognized by PC properly, the USB indicator blinks slowly.

**4] Play back audio source on a PC**

Play back an audio source on audio player software.

### Audio Player Software for High Resolution Audio Playback

Prepare audio player software supports the high-resolution PCM and the DSD playback to play back those audio sources.

**For Windows® PC users;**

Install foobar2000 and the components from the supplied setup CD. Please see 4-3 installing foobar2000.

**For Mac® users;**

Use audio player software available in the marketplace.

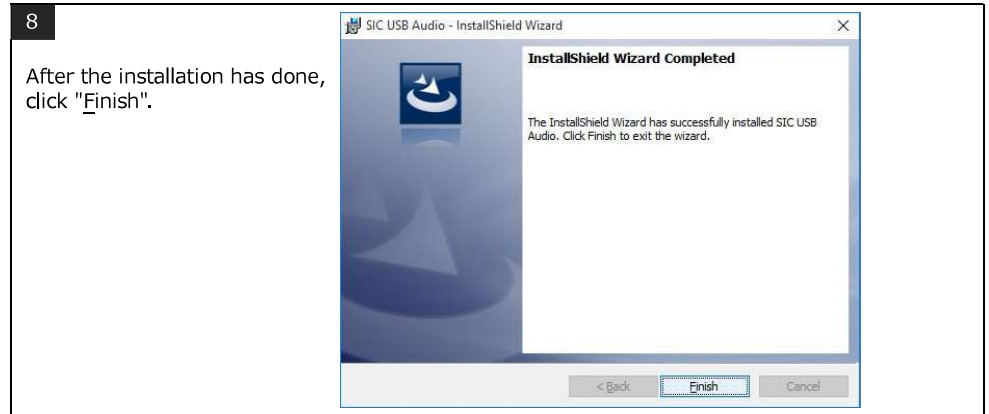

## 4-3 Installing foobar2000

The product is confirmed compatible on foobar2000 and the components in the supplied setup CD. Please note that it may not operate properly or procedure of installation may differ when using other versions.

For more information about detailed usage and troubleshooting of foobar2000, please check information on the Internet, magazines, etc.

### 4-3-1 Installing ASIO Proxy

To play back DSD on foobar2000, install ASIO Proxy according to the following instructions.

1

Copy "foo\_input\_sacd-0.8.4.zip" to an arbitrary folder such as desktop.

- ※ Extract "foo\_input\_sacd-0.8.4.zip" after copying the file to the local disk. When extracted directly from the CD folder, it may not extract all of the files.
- ※ The last digit of the file may vary depending on versions.

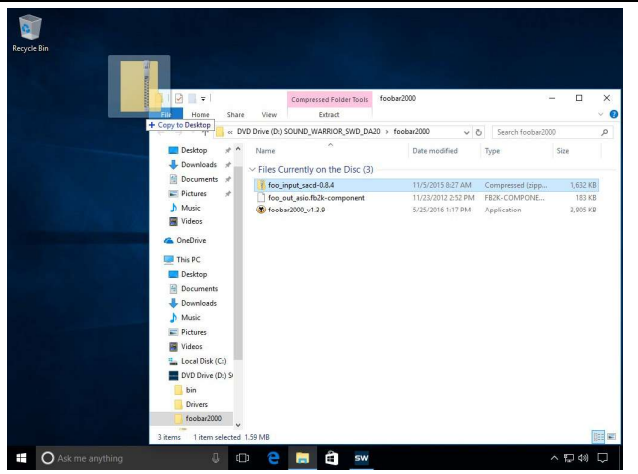

The latest version can be downloaded from the following website.  
[http://sourceforge.net/projects/sacddecoder/files/foo\\_input\\_sacd/](http://sourceforge.net/projects/sacddecoder/files/foo_input_sacd/)

2

Extract "foo\_input\_sacd-0.8.4.zip" to an arbitrary folder.

- ※ The last digit of the file may vary depending on versions.
- ※ The image shows the standard menu of Windows® 10. When compression software is installed, the menu may look different.

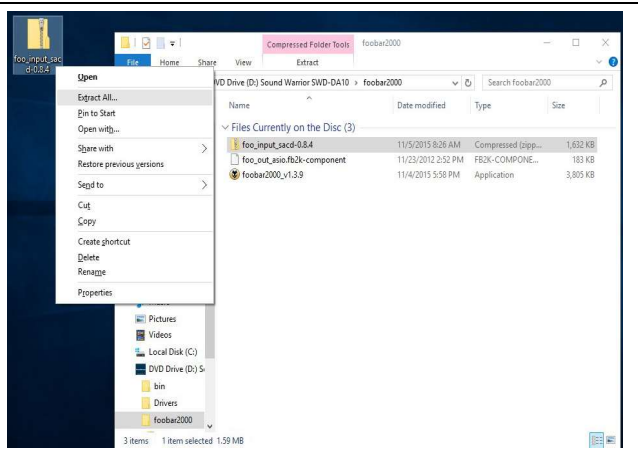

7

Select "Tools" -> "SACD" in the left pane.

Select "DSD" as "ASIO Driver" in the right pane.

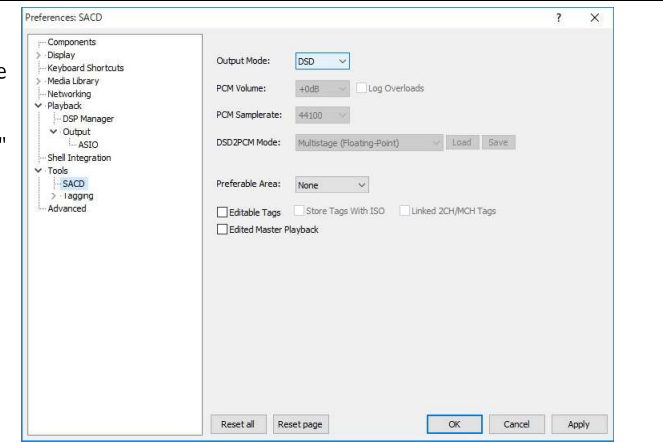

8

Select "Playback" -> "Output" from the left pane.

Select "ASIO: foo\_dsd\_asio" in the "Device" column.

Click "OK" to close "Preferences" window.

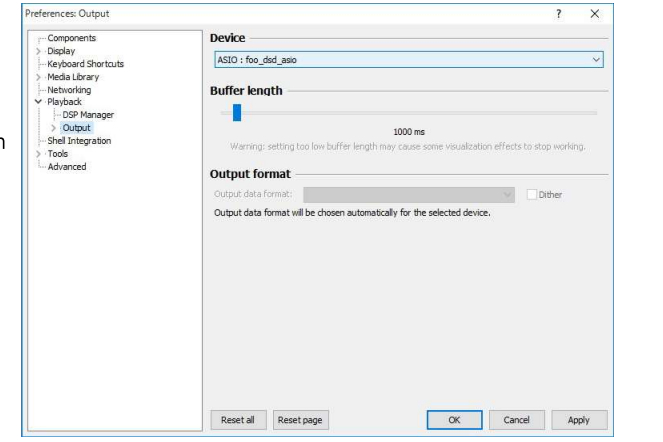

4

Select "SIC USB Audio" as "ASIO Driver:".  
 Select "DoP Marker 0x05/0xFA" as "DSD Playback Method:".

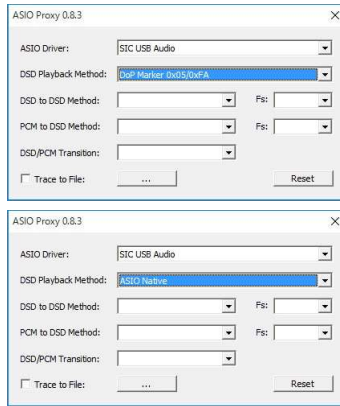

Select "ASIO Native" as "DSD Playback Method:" when played back with ASIO native method.

5

Double-click "SIC USB Audio" in "ASIO drivers" column.

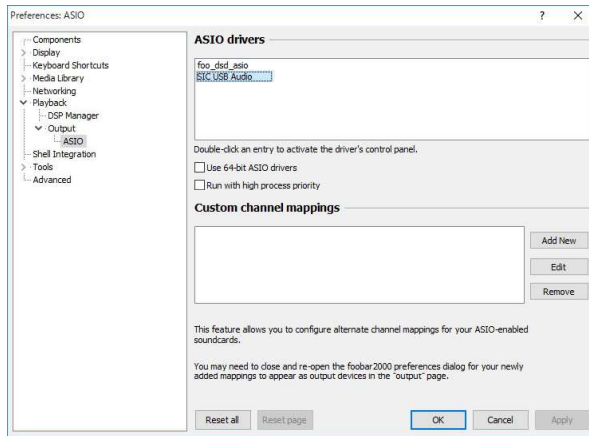

6

Buffer size can be adjusted in "SIC USB Audio Control Panel".

If there is a problem with intermittent sound, increase the buffer size.

If the SWD-DA20US is not connected to a PC properly, the "Buffer Size" is unable to be adjusted.

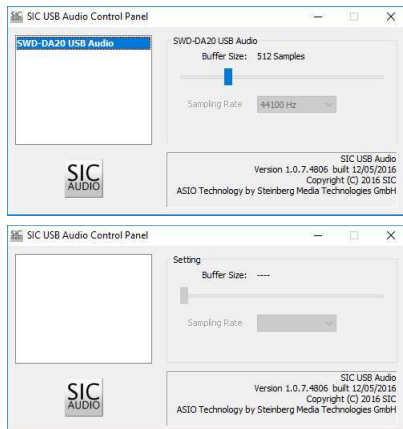

3

Select a destination.

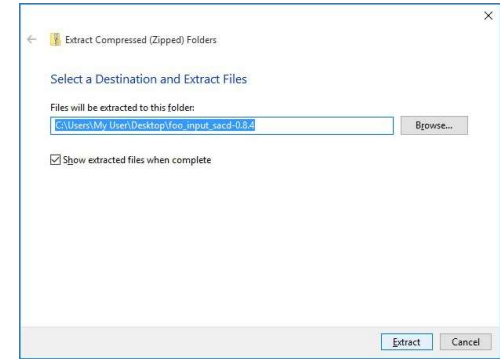

4

Open the extracted folder and run "ASIOProxyInstall-0.8.3.exe".

⌘ The last digit of the file may vary depending on versions.

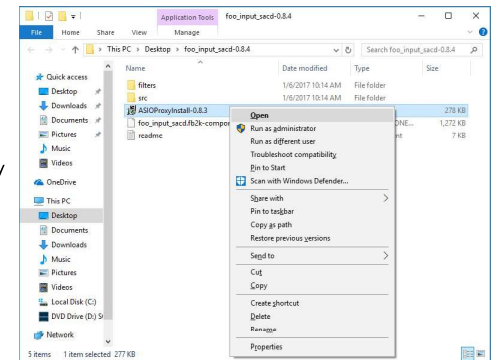

5

Click "Yes".

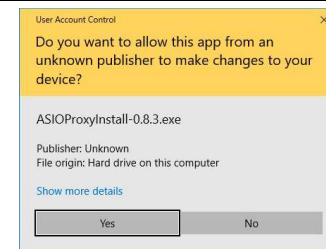

6

Click "Next >".

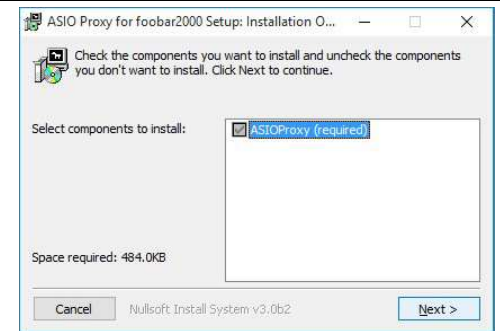

7

Select a destination and click "Install".

※ There is usually no need to change it.

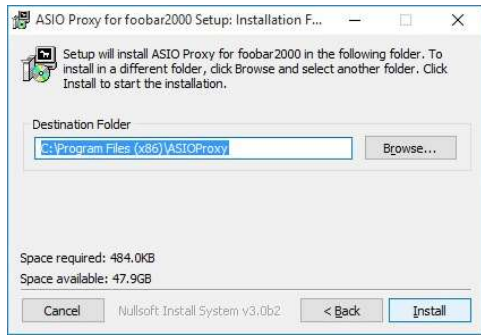

8

After installation has done, click "Close". When updated from an older version of ASIO Proxy, restart a PC.

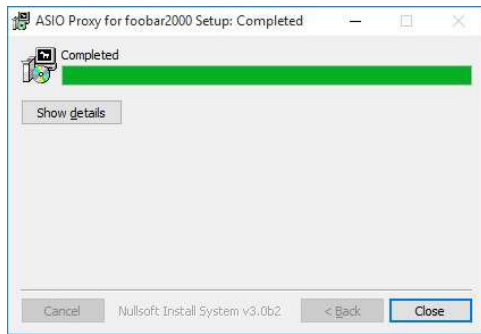

## 4 - 4 Setting Up foobar2000

### 4 - 4 - 1 Setting Up foobar2000

1

Connect SWD-DA20US to a PC.

Open "Preferences" window by selecting "File" -> "Preferences" from the menu bar.

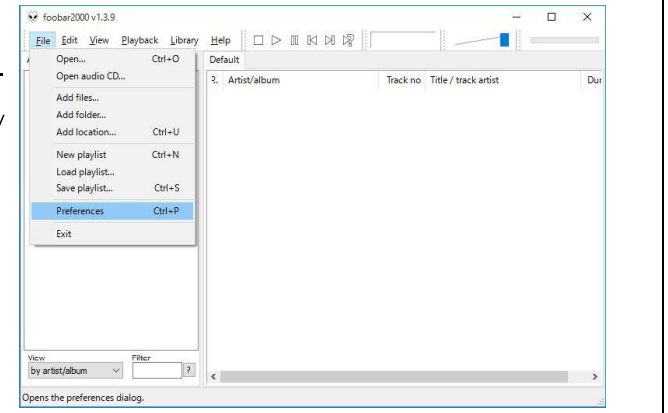

2

Select "Playback"-> "Output"-> "ASIO" from the left pane.

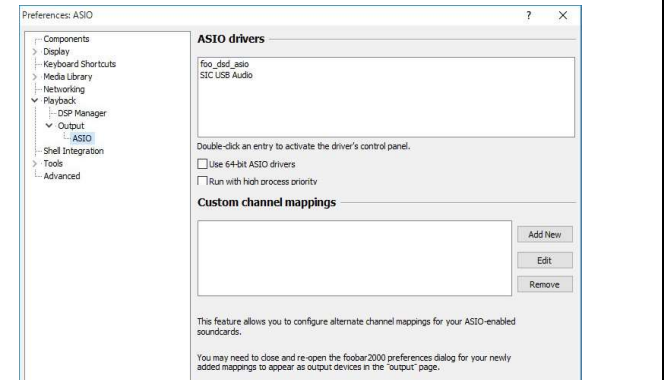

3

Double-click "foo\_dsd\_asio" in "ASIO drivers" column.

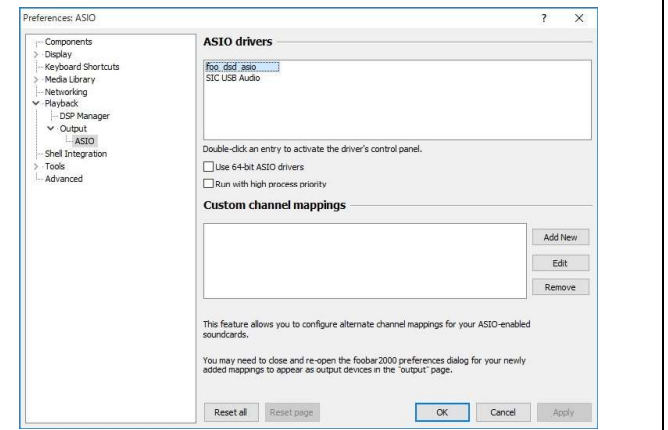



4-3-2 Installing foobar2000

The latest software can be downloaded from the following link.  
<http://www.foobar2000.org/download>

4

Drag and drop "foo\_out\_asio.fb2k-component" into the right pane.

1

Run "foobar2000\_v1.3.9.exe" in "foobar2000" folder.

✘ The last digit of the file may vary depending on versions.

5

Check if "foo\_input\_sacd" and "foo\_out\_asio" is added and then click "Apply".

2

Click "Next >".

6

Click "OK" and restart foobar2000.

3

Read "License Agreement" and click "I Agree".

7

Click "Yes".

4

Select "Standard installation" and click "Next >".

**5**

Click "Yes".

**6**

Select a destination and click "Next >"

※ There is usually no need to change it.

**7**

Select "Full" at "Select the type of install:" and click "Install".

**8**

After the installation has done, "Quick Appearance Setup" appears. Select your choice of design.

### 4 - 3 - 3 Adding Components

Download the latest version of foobar\_input\_sacd from the following website.  
[http://sourceforge.net/projects/sacddecoder/files/foobar\\_input\\_sacd/](http://sourceforge.net/projects/sacddecoder/files/foobar_input_sacd/)  
 Download the latest version of foobar\_out\_asio from the following website.  
[http://www.foobar2000.org/components/view/foobar\\_out\\_asio](http://www.foobar2000.org/components/view/foobar_out_asio)

※ Please note that it may not operate properly when using different components versions from the supplied setup CD.

**1**

Select "File" -> "Preferences" from the menu bar.

**2**

Select "Components" from the left pane.

Name	Version	Module
Album List	4.5	foo_albumlist
CD Audio Decoder	3.0	foo_cdta
Converter	1.5	foo_converter
Default User Interface	0.9.5	foo_ui_std
Equalizer	1.0	foo_dsp_eq
File Operations	2.2.1	foo_fileops
foobar2000 core	1.3.9	Core
Online Tagger	0.7	foo_feedb2
ReplayGain Scanner	2.2.2	foo_rgscan
Standard DSP Array	1.3.1	foo_dsp_std
Standard Input Array	1.0	foo_input_std
ZIP/GZIP/RAR Reader	1.7.1	foo_unpack

**3**

Open a folder which extracted "foobar\_input\_sacd-0.8.4.zip".

※ Please see "4 - 3 - 1 Installing ASIO Proxy" for details.

Drag and drop "foobar\_input\_sacd.fb2k-component" into the right pane.